



# LEICA **NOCTILUX-M** 75 mm f/1.25 ASPH.

Technical Data.



Illustration 1:1

<b>Lens</b>	<b>Leica Noctilux-M 75 mm f/1.25 ASPH.</b>
Order no.	11 676
Angle view (diagonal, horizontal, vertical)	For 35 mm (24x36 mm): approx. 32°/27°/18°, for M8: approx. 24°/20°/14°
Optical design	Number of elements/groups: 9/6 Entrance pupil for bayonet: 26.9 mm Focusing range: 0.85 m to infinity
Distance setting	Scala: combined meter-/feet-increments Smallest object field: for 35 mm: 212x318 mm; for M8: 159x238 mm Highest reproduction ratio: 1:8.8
Diaphragm	Setting/type: preset, with click-stops, half values available Smallest aperture: f/16 Number of aperture blades: 11
Bayonet	Leica M quick-change bayonet
Filter thread	E67
Lens hood	Integrated
Dimensions and weight	Length: approx. 91/102 mm (without/with extended lens hood) Diameter: approx. 74 mm Weight: approx. 1055 g



# LEICA **NOCTILUX-M** 75 mm f/1.25 ASPH.

ENGINEERING DRAWING



Illustrations 1:1

LENS SHAPE

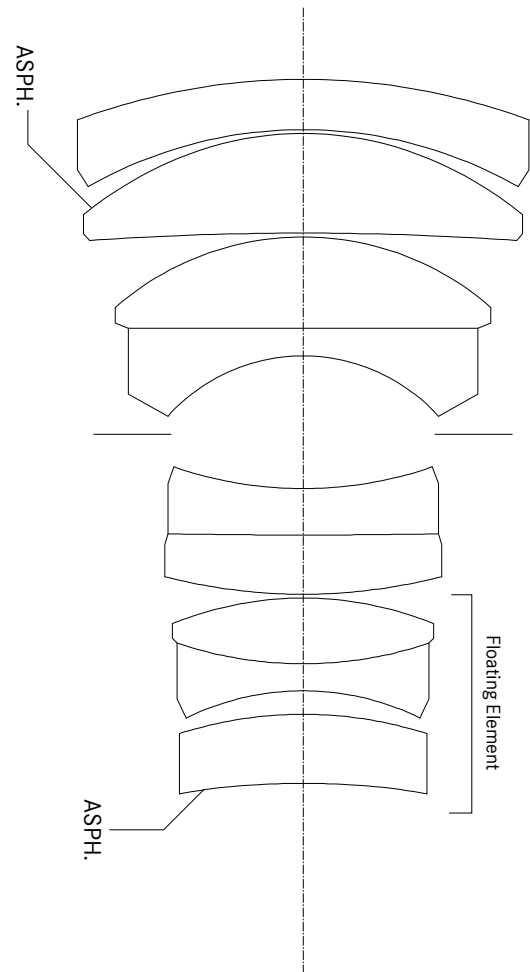

The Leica Noctilux-M 75 mm f/1.25 ASPH. is a unique, high-performance lens that enables photographers to lend their images an extraordinary visual signature. The combination of extraordinarily shallow depth of field at maximum aperture and outstanding imaging performance from infinity to its closest focusing distance, opens up entirely new possibilities for creative photography.

To achieve this, the reduction of the dimensions and weight of the lens presented entirely new challenges in the fields of optical design, construction and manufacturing.

- Very high quality imaging performance from corner to corner of the image frame through correction of all aberrations. This applies in particular to the closer focusing range (portrait distances), and was achieved by the use of a floating element.
- Extremely shallow depth of focus at maximum aperture (only half that of the Leica Noctilux-M 50 mm f/0.95 ASPH.) enables isolation of subject details with a 'macro-feel'.
- Imaging performance (stopped down to f/2) exceeds that of the Leica APO-Summicron-M 75 mm f/2 ASPH.
- Round aperture creates extremely harmonious bokeh (11 iris blades).
- Despite a complex focusing system (floating element), the highest precision ensures consistency throughout the entire focusing range.
- Minimal reflections and stray light thanks to high-quality lens coatings.
- Integrated, twist-out-and-lock lens hood.



# LEICA **NOCTILUX-M** 75 mm f/1.25 ASPH.

## MTF-DIAGRAMS

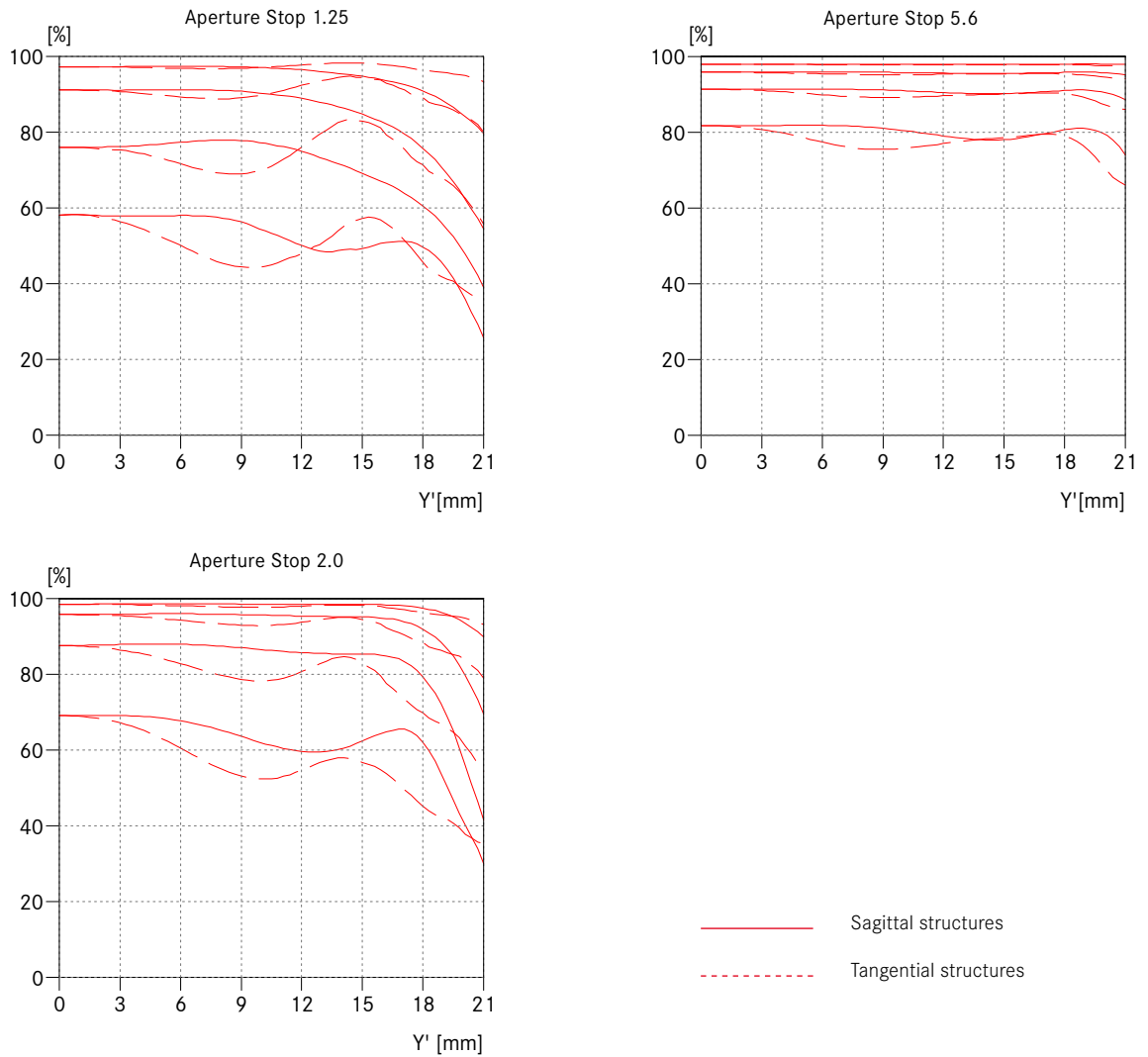

**MTF GRAPHS** The MTF is shown in each case for the maximum aperture 1.25 and the aperture values 2.0 and 5.6 for long focusing distances (infinity). The contrast is plotted for 5, 10, 20, 40 lines/mm for the height of the format for tangential (dashed line) and sagittal structures (continuous line) for white light. The plots for 5 and 10 lines/mm provide an impression of the contrast performance for coarser object structures and the 20 and 40 lines/mm plots document the resolving power for fine and finest object structures.



# LEICA **NOCTILUX-M** 75 mm f/1.25 ASPH.

## DISTORTION

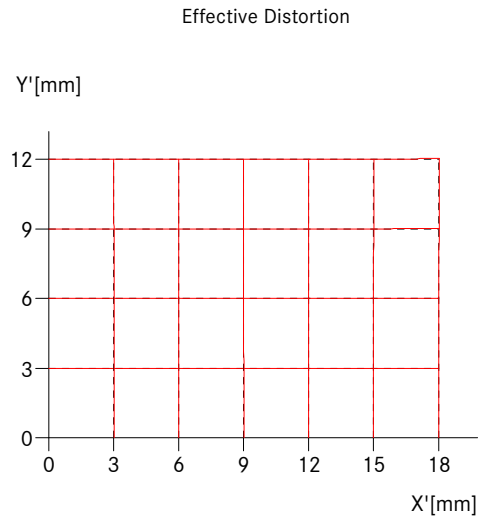
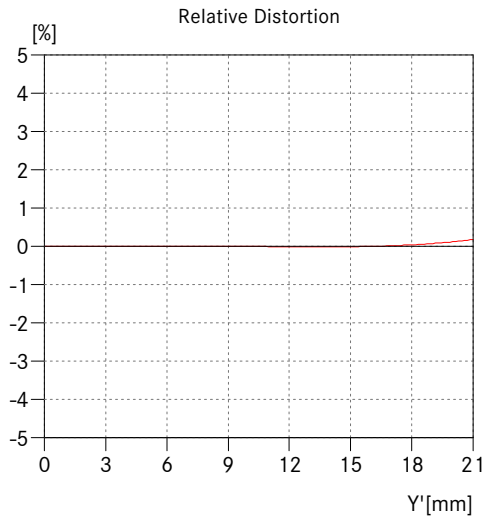

## VIGNETTING

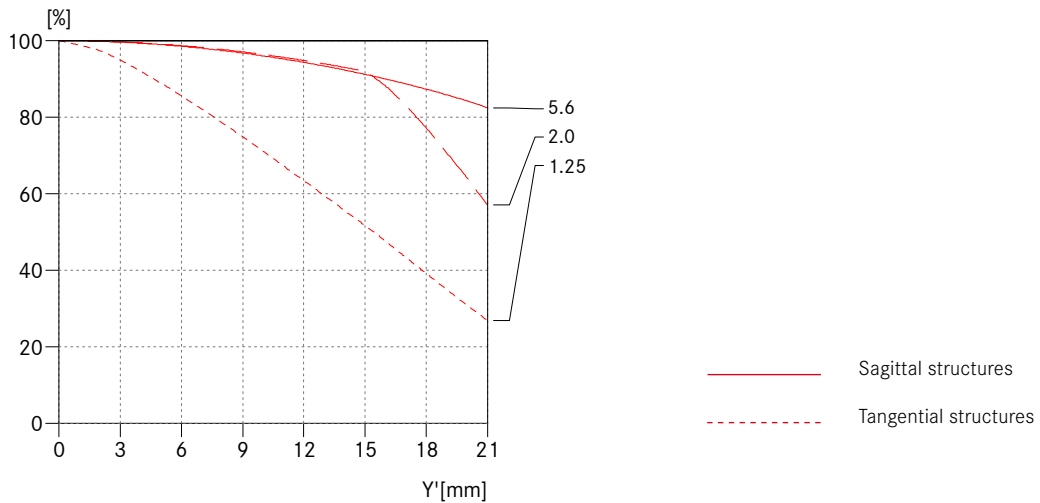

**DISTORTION** Distortion is the deviation of the real image height (in the picture) from the ideal image height. The relative distortion is the percentage deviation. The ideal image height results from the object height and the magnification. The image height of 21.6 mm is the radial distance between the edge and the middle of the image field for the format 24 mm x 36 mm. The graph of the effective distortion illustrates the appearance of straight horizontal and vertical lines in the picture.

**VIGNETTING** Vignetting is a continuous decrease of the illumination to the edges of the image field. The graph shows the percentage loss of illumination over the image height. 100% means no vignetting.



# LEICA **NOCTILUX-M** 75 mm f/1.25 ASPH.

DEPTH OF FIELD TABLE

Distance Setting [m]	Aperture Stop										Magnification
	1,25	1,4	2,0	2,8	4,0	5,6	8,0	11,0	16,0		
0,85	0,846 - 0,854	0,845 - 0,855	0,843 - 0,857	0,841 - 0,860	0,837 - 0,864	0,831 - 0,870	0,824 - 0,878	0,814 - 0,890	0,799 - 0,909	1/8.8	
1	0,994 - 1,006	0,993 - 1,007	0,990 - 1,010	0,986 - 1,014	0,981 - 1,020	0,973 - 1,028	0,962 - 1,041	0,949 - 1,058	0,927 - 1,086	1/10.8	
1,2	1,191 - 1,209	1,190 - 1,210	1,186 - 1,215	1,180 - 1,221	1,172 - 1,230	1,160 - 1,243	1,144 - 1,262	1,125 - 1,287	1,094 - 1,331	1/13.5	
1,5	1,485 - 1,515	1,484 - 1,517	1,477 - 1,524	1,468 - 1,534	1,454 - 1,549	1,437 - 1,569	1,412 - 1,601	1,381 - 1,643	1,333 - 1,717	1/17.5	
2	1,973 - 2,028	1,971 - 2,031	1,958 - 2,044	1,942 - 2,062	1,918 - 2,09	1,886 - 2,129	1,842 - 2,189	1,789 - 2,27	1,707 - 2,419	1/24.1	
3	2,937 - 3,066	2,932 - 3,071	2,904 - 3,103	2,867 - 3,146	2,814 - 3,213	2,746 - 3,308	2,650 - 3,46	2,539 - 3,672	2,374 - 4,091	1/37.4	
5	4,825 - 5,189	4,811 - 5,205	4,734 - 5,298	4,635 - 5,429	4,494 - 5,636	4,320 - 5,9	4,082 - 6,46	3,820 - 7,257	3,452 - 9,143	1/63.9	
10	9,314 - 10,80	9,261 - 10,87	8,976 - 11,29	8,622 - 11,9	8,142 - 12,97	7,579 - 14,72	6,869 - 18,46	6,149 - 27,08	5,237 - 123,2	1/130.1	
∞	133,7 - ∞	123,5 - ∞	86,44 - ∞	61,74 - ∞	43,23 - ∞	30,90 - ∞	21,64 - ∞	15,76 - ∞	10,85 - ∞	1/∞	

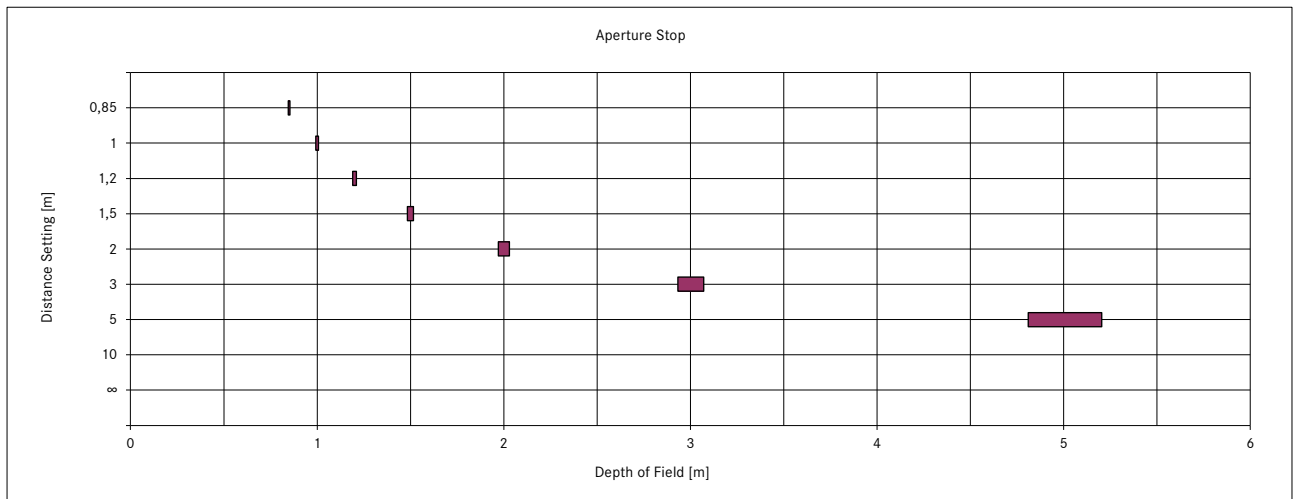
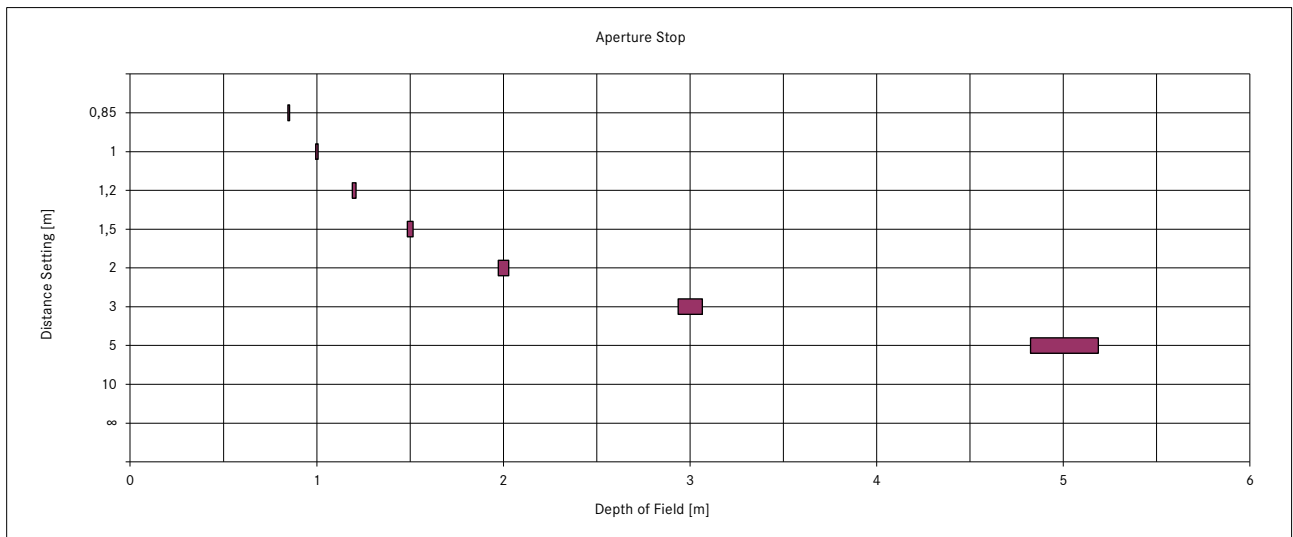



# LEICA **NOCTILUX-M** 75 mm f/1.25 ASPH.

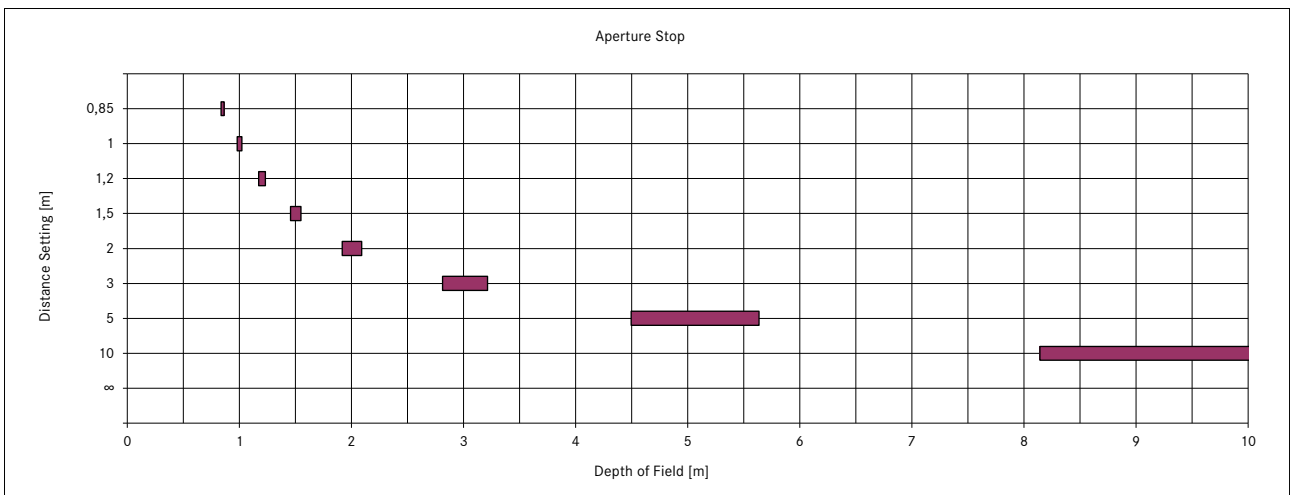
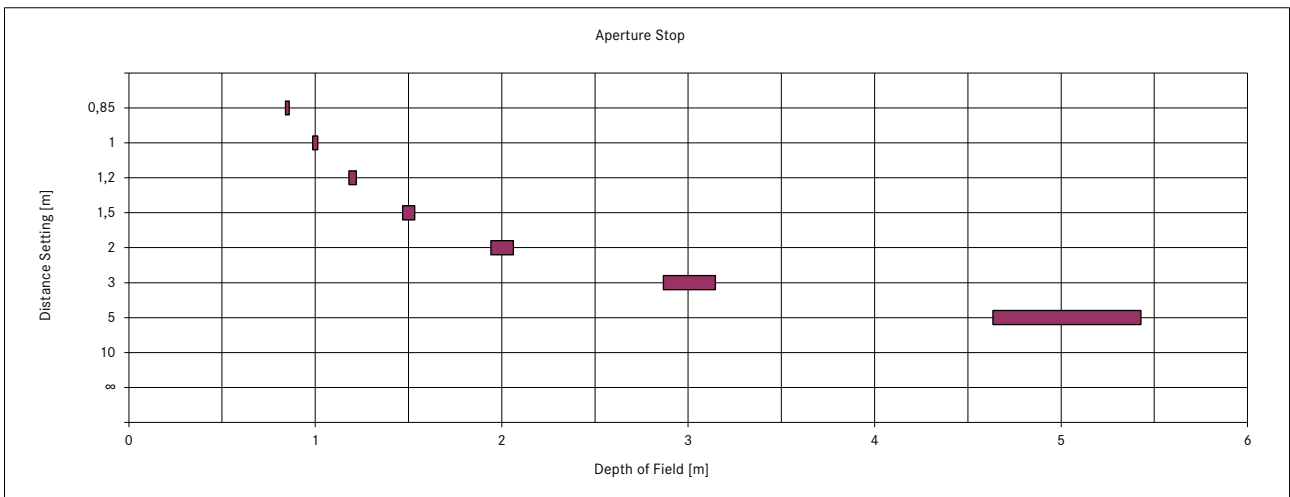
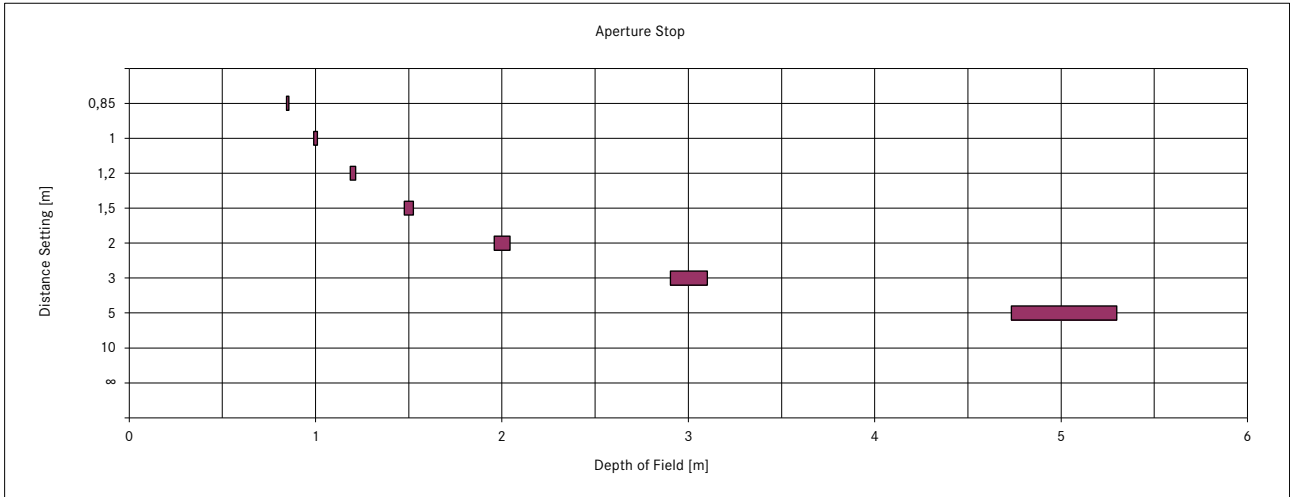



# LEICA **NOCTILUX-M** 75 mm f/1.25 ASPH.

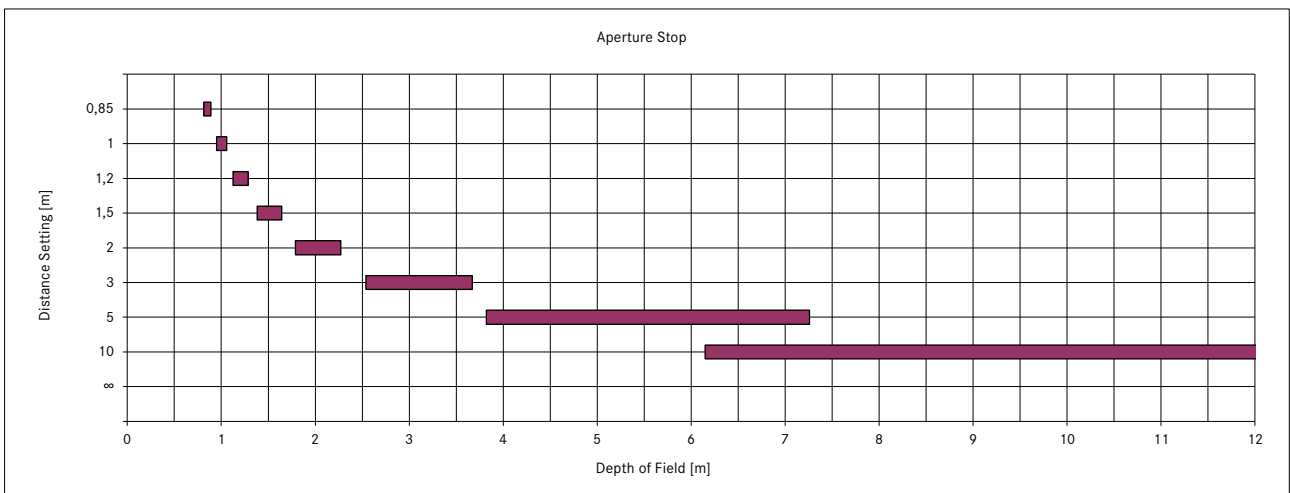
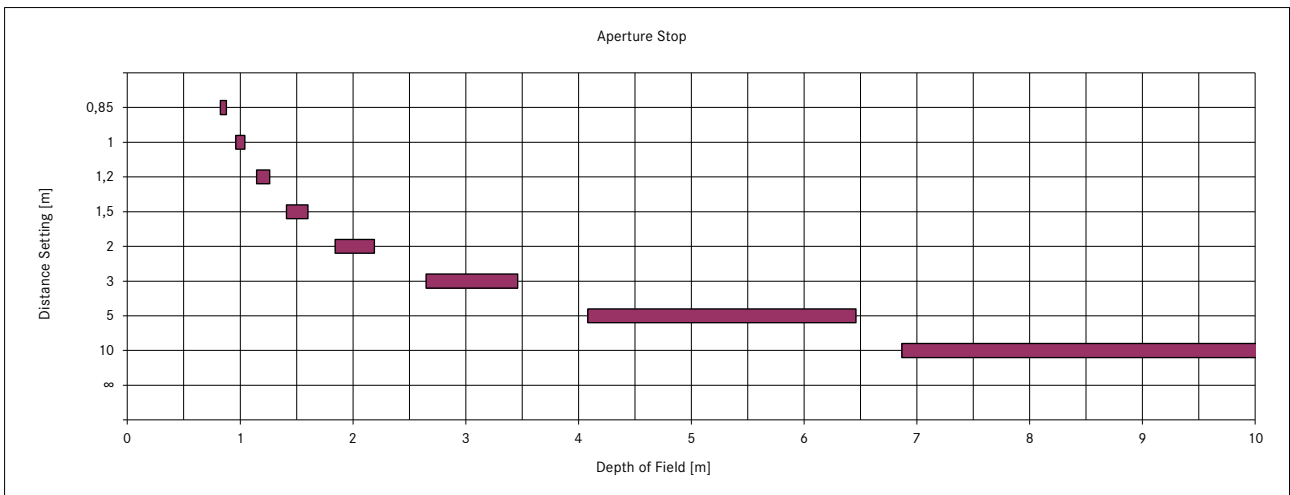
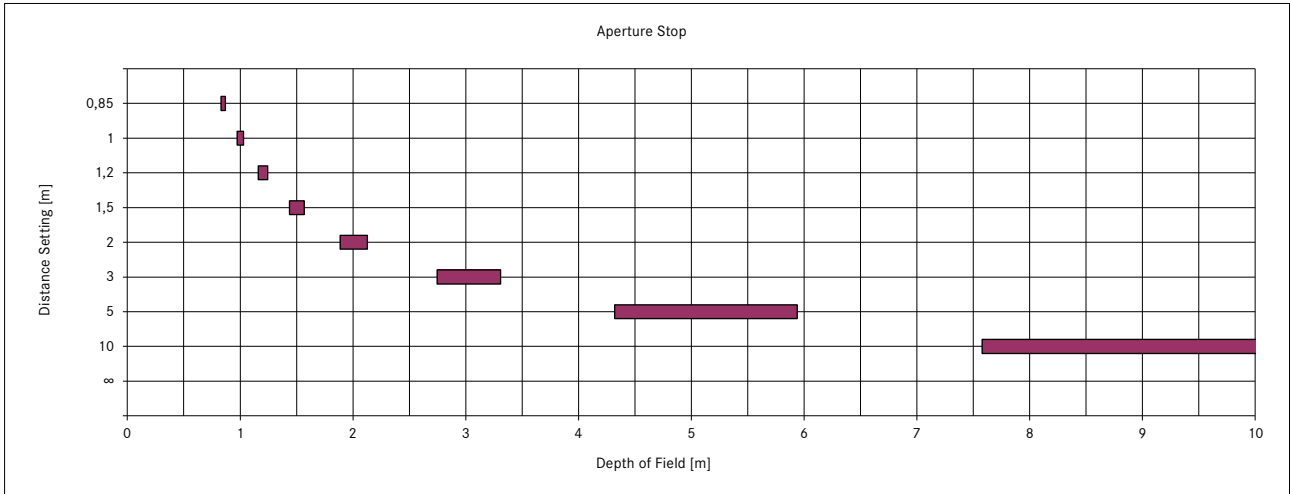



# LEICA **NOCTILUX-M** 75 mm f/1.25 ASPH.

